

LED Stop, Tail, Turn & Backup Truck Lights - Model 265

PRODUCT INFORMATION

Description	12-24V ECE/SAE LED Stop, Tail, Turn Signal & Backup Light
Height	136.65 mm / 5.38 in
Width	287.53 mm / 11.32 in
Depth	33.78 mm / 1.33 in
Shape	Rectangular
Outer Lens Material	Acrylic
Outer Lens Color	Amber, Clear, Red
Housing Material	ABS
Housing Color	Black
Mounting Hardware Description	(x2) M6-1 x 25mm Mounting Bolts
Mounting Type	Low Profile Mount
Minimum Operating Temperature	-40 °C / -40 °F
Maximum Operating Temperature	65 °C / 149 °F
Connector or Wiring	6-Pin Deutsch Socket (DT04-6P-E004); Others available
Mating Connector	6-Pin Deutsch Plug (DT06-6S); Others Available
Product Weight	1.34 lbs / 0.61 kgs
Shipping Weight	1.34 lbs / 0.61 kgs



Print date: 2024-08-11

© 2024 J.W. Speaker Corporation • Germantown, WI U.S.A.
www.jwspeaker.com • speaker@jwspeaker.com • 262.251.6660

J.W. SPEAKER 
Engineered. Lighting. Solutions.

LED Stop, Tail, Turn & Backup Truck Lights - Model 265

PRODUCT DIMENSIONS

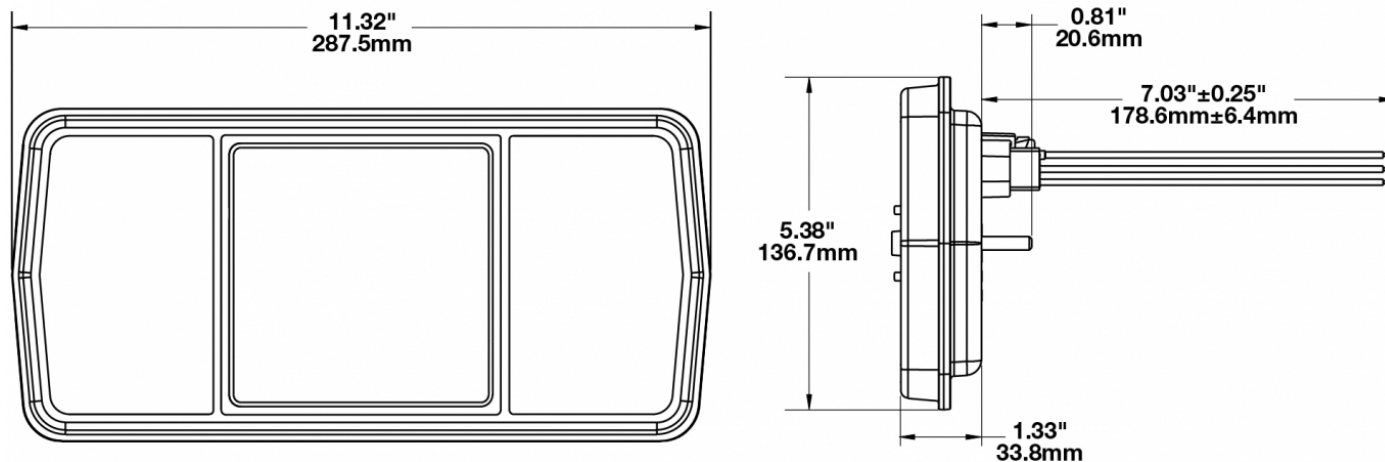

ELECTRICAL SPECIFICATIONS

Input Voltage	12-24V DC
White Wire	Reverse
Yellow Wire	Turn
Red Wire	Stop
Brown Wire	Tail
Black Wire	Ground
Current Draw	0.115A @ 12V DC (Stop)
	0.075A @ 24V DC (Stop)
	0.010A @ 12V DC (Tail)
	0.010A @ 24V DC (Tail)
	0.115A @ 12V DC (Turn)
	0.080A @ 24V DC (Turn)
	0.045A @ 12V DC (Reverse)
	0.028A @ 24V DC (Reverse)

Print date: 2024-08-11

© 2024 J.W. Speaker Corporation • Germantown, WI U.S.A.
www.jwspeaker.com • speaker@jwspeaker.com • 262.251.6660

LED Stop, Tail, Turn & Backup Truck Lights - Model 265

REGULATORY STANDARDS COMPLIANCE



ASABE S279	Buy America Standards
ECE Reg 23	ECE Reg 3
ECE Reg 6	ECE Reg 7
Eco Friendly	FMVSS 108 s7.1 (Table VII)
FMVSS 108 s7.2 (Table VIII)	FMVSS 108 s7.3 (Table IX)
FMVSS 108 s7.6 (Table XII)	FMVSS 108 s8.1 (Table XVI)
IEC IP67	SAE J2040
SAE J2261	SAE J575
SAE J585	SAE J586
SAE J588	SAE J593
SAE J594	

PHOTOMETRIC SPECIFICATIONS

Beam Pattern(s)	Signalization - Stop
	Signalization - Tail
	Signalization - Turn (Front)
	Signalization - Turn (Rear)

APPLICATIONS



Print date: 2024-08-11

© 2024 J.W. Speaker Corporation • Germantown, WI U.S.A.
www.jwspeaker.com • speaker@jwspeaker.com • 262.251.6660

J.W. SPEAKER
Engineered. Lighting. Solutions.

LED Stop, Tail, Turn & Backup Truck Lights - Model 265

PRODUCT WARNINGS

For California residents:

⚠ **WARNING:** Cancer and reproductive harm - www.P65Warnings.ca.gov.

⚠ **AVERTISSEMENT:** Cancer et effet nocif sur la reproduction - www.P65Warnings.ca.gov.

Print date: 2024-08-11

© 2024 J.W. Speaker Corporation • Germantown, WI U.S.A.
www.jwspeaker.com • speaker@jwspeaker.com • 262.251.6660

J.W. SPEAKER 
Engineered. Lighting. Solutions.